



Commercial Kitchen Exhaust and Filtration Solutions

Don't Let Your Food Taste Be Poisoned!

A chemical called Polycyclic Aromatic Hydrocarbon appears as a result of the contact of fat dripping from meat with coal during cooking. This chemical rises into the air as a smoke, and people who inhale the smoke inhale these toxic substances.



About Us

Emsa Engineering started its activities in 1989 by working on heating-cooling and ventilation systems with the awareness of the importance of air quality. In 2010, it focused on solving oil, smoke and odor problems in industrial kitchens, and by combining its 30 years of experience with high technology, it became fully air quality engineering. We have succeeded to be one of the most reliable companies in the sector with more than 1000 projects successfully completed.

Our Vision

The biggest problem of the rapidly developing food and beverage sector is the removal of oil, smoke and odor. The release of oil, smoke and odor during the cooking to the atmosphere through a chimney causes serious disturbance to the environment and also pollutes the air we breathe. In addition, a large portion of the oil vapor drawn directly by the chimney is solidified and the air accumulates inside the channel. This causes narrowing of the channel cross-sections and reduces the flow quality of the air. However, the most important thing is that the oil accumulated in the channel ignites because of the sparks that will occur when the grill is burned, causing a serious fire in the restaurant.

Our Mission

Our mission is to meet or exceed the expectations of our customers by providing superior and innovative air cleaning equipment, exceptional technical support and operational excellence.

We serve our customers by designing, producing and marketing the most cost-effective high quality air purifiers in the industry. We maintain our activities on the basis of providing practical productive equipment and honest answers, and we believe that fulfilling our promises is one of our most effective sales tools.

Our Exports

- Albania
- Algeria
- Azerbaijan
- Britain
- Bulgaria
- Germany
- Holland
- Hungary
- Iraq
- Kazakhstan
- Montenegro
- Romania
- Serbia
- Spain
- South Africa
- UAE





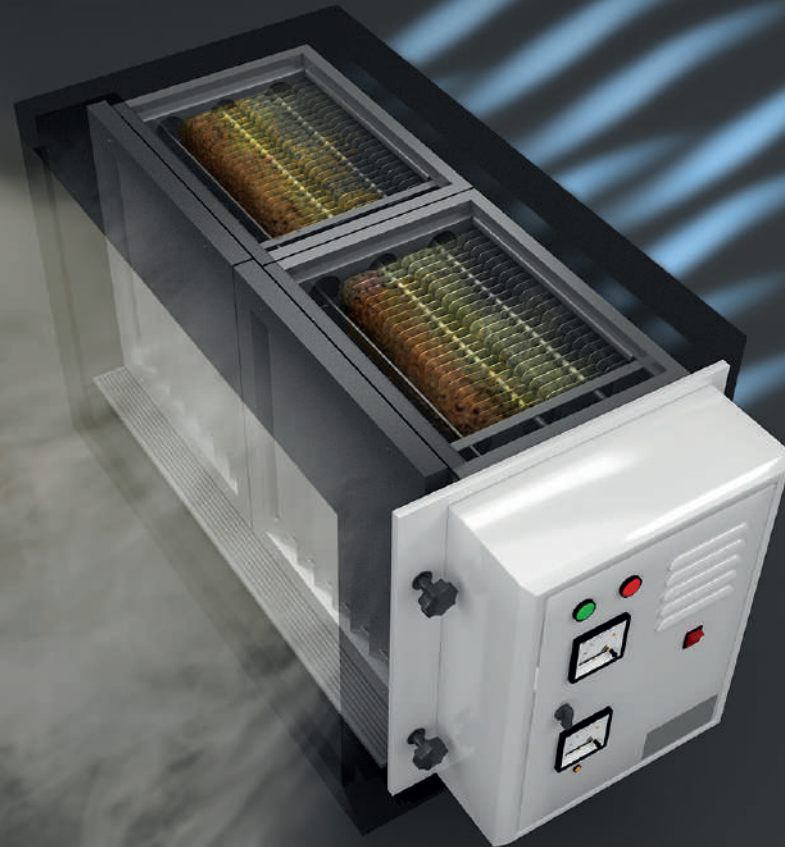

HORECA HMD series Duct Type Electrostatic Filter removes polluted air by absorbing particles such as oil, steam, dust and smoke formed in the air with the principle of electrostatic precipitation.



ELECTROSTATIC FILTER

Advantages

- Chimney fire risk significantly reduced.
- Operating expenses are reduced.
- The exhaust fan's life is extended.
- Oily and odorous smoke will be purified discharged from the duct.
- Lubrication in the channels is prevented.



HMD-300



HMD-600



HMD-900

Working Principle

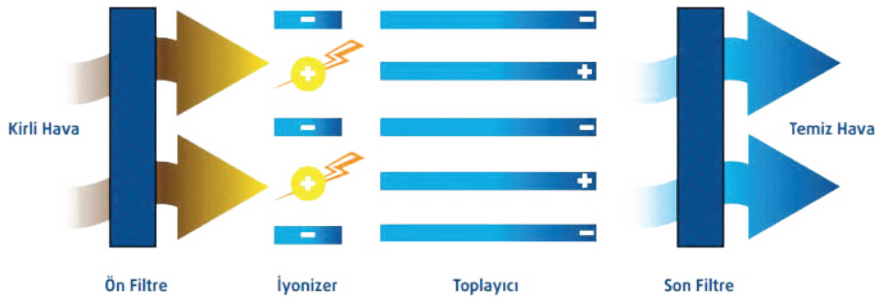

1. Stage

The air drawn by the exhaust fan passes through the coarse particle holder metal filter of the HORECA HMD series duct type electrostatic filter, where it is purified from large particles.

2. Stage

Particles with the size of $0.3\mu\text{m}$ pass through the high voltage electric field region. Here the particles are charged with a positive electric charge.

3. Stage

These positively charged particles are retained by evenly spaced parallel arrays of collecting plates. These surfaces are negatively and positively charged, respectively. Positively charged surfaces repel these particles, while negatively charged surfaces attract and collect them.

4. Stage

In this way, the oil particles formed during cooking adhere to the aluminum plates. At the same time, it flows into the oil pan at the bottom. Filters and oil pan are cleaned and reassembled periodically.



HMD-1800



HMD-2700

HORECA Elektrostatic Filter,

With the right project and equipment selection, it filters the oil vapor and smoke formed during cooking **by 98%**.

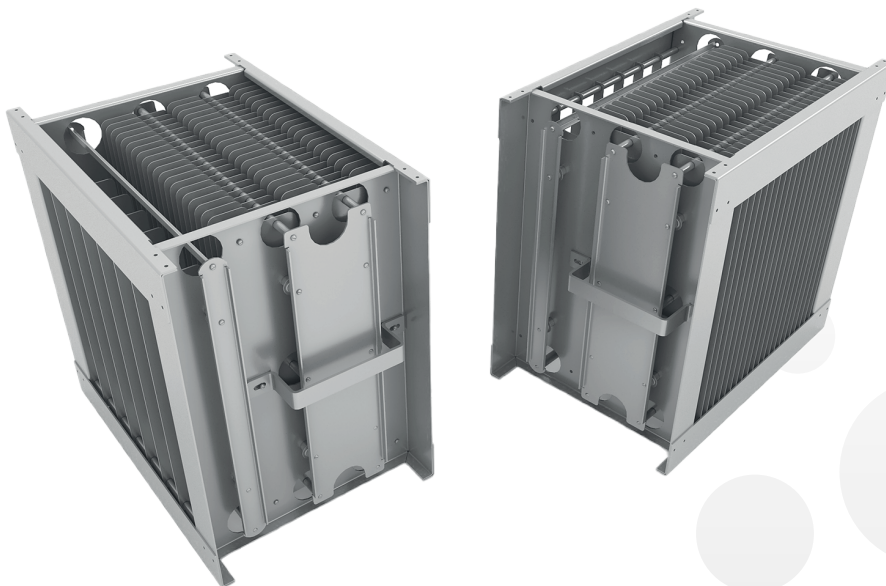

**WE ARE
FOCUSED FOR
CLEAN AIR**



Device Specifications

Single Pass Application

Between 3,000 m³ / h and 9,000 m³ / h air flow rates, where there is light cooking intensity used. Channel type or in a ecology unit applicable.



Stacked Application

It is used in points where it is air flows of 9,000 m³ / h and above, Stacking device the capacity increases by increasing the number. Channel type or can be applied in ecology unit.



Double-Pass Application

Applied where cooking density is heavy. Particles that the first filter will miss, the second pass filter keeps. It is also applied by stacking, there is no limit in air flow. Depends on the situation It can also be applied in three passes. Used, channel type or in a ecology unit.



Ecology Unit

Pre-filter, electrostatic filter, activated carbon filter and fan can be applied as fixed or modular is a compact system. It can work comfortably in environments that may be exposed to external factors such as roof, terrace etc.



Technical Specifications



MODEL	HMD-300	HMD-600	HMD-900
CAPACITY (98,7 % Efficiency)	2.500 m ³ /h	5.000 m ³ /h	7.500 m ³ /h
CAPACITY (%94,5 Efficiency)	3.000 m ³ /h	6.000 m ³ /h	9.000 m ³ /h
EFFICIENCY (0,3 µm)	98,7 %	98,7 %	98,7 %
COLLECTOR CELL	1 PCS	2 PCS	3 PCS
COLLECTOR SURFACE AREA	17,2 M ²	34,4 M ²	51,6 M ²
PRESSURE LOSS	150 Pa	150 Pa	150 Pa
INPUT VOLTAGE AND FREQUENCY	220 V / 50 Hz	220 V / 50 Hz	220 V / 50 Hz
POWER CONSUMPTION	0,3 kW/h	0,3 kW/h	0,3 kW/h
STAINLESS PRE-FILTER	Included	Included	Included
STAINLESS BACK FILTER	Optional	Optional	Optional
OIL DRAIN TAP	Included	Included	Included
DEVICE DIMENSIONS (AxBxC)	690 mm x 600 mm x 550 mm	1170 mm x 600 mm x 550 mm	1640 mm x 600 mm x 550 mm
DUCT INPUT DIMENSIONS (DxE)	503 mm x 450 mm	503 mm x 927 mm	503 mm x 1417 mm
COLLECTOR CELL DIMENSIONS (FxWxH)	470 mm x 464 mm x 324 mm	470 mm x 464 mm x 324 mm	470 mm x 464 mm x 324 mm
FRONT/REAR FILTER DIMENSIONS (JxKxL)	475 mm x 460 mm x 16 mm	475 mm x 460 mm x 16 mm	475 mm x 460 mm x 16 mm
MAINTENANCE AREA DIMENSIONS (MxN)	1000 mm x 1000 mm	1000 mm x 1000 mm	1000 mm x 1000 mm
ORIGIN	TURKEY	TURKEY	TURKEY

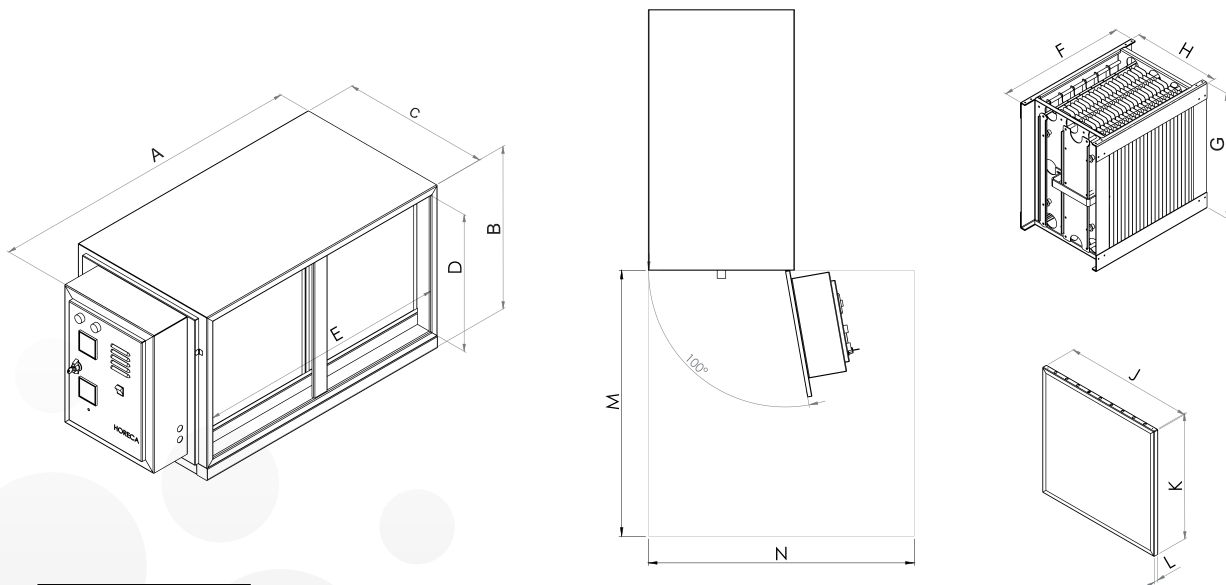

Technical Specifications



MODEL	HMD-1200	HMD-1800	HMD-2700
CAPACITY (%98,7 Efficiency)	10.000 m³/h	15.000 m³/h	22500 m³/h
CAPACITY(%94,5 Efficiency)	12.000 m³/h	18.000 m³/h	27.000 m³/h
EFFICIENCY (0,3 µm)	98,7 %	98,7 %	98,7 %
COLLECTOR CELL	4 PCS	6 PCS	9 PCS
COLLECTOR SURFACE AREA	68,8 M²	103,2 M²	154,8 M²
PRESSURE LOSS	150 Pa	150 Pa	150 Pa
INPUT VOLTAGE AND FREQUENCY	220 V / 50 Hz	220 V / 50 Hz	220 V / 50 Hz
POWER CONSUMPTION	0,6 kW/h	0,6 kW/h	0,9 kW/h
STAINLESS PRE-FILTER	Included	Included	Included
STAINLESS BACK FILTER	Optional	Optional	Optional
OIL DRAIN TAP	Included	Included	Included
DEVICE DIMENSIONS (AxBxC)	1170 mm x 1200 mm x 550 mm	1640 mm x 1200 mm x 550 mm	1640 mm x 1800 mm x 550 mm
DUCT INPUT DIMENSIONS (DxE)	1103 mm x 927 mm	1103 mm x 1417 mm	1103 mm x 1417 mm
TOPLAYICI HÜCRE ÖLÇÜLERİ (FxGxH)	470 mm x 464 mm x 324 mm	470 mm x 464 mm x 324 mm	470 mm x 464 mm x 324 mm
FRONT/REAR FILTER DIMENSIONS (JxK)	475 mm x 460 mm x 16 mm	475 mm x 460 mm x 16 mm	475 mm x 460 mm x 16 mm
MAINTENANCE AREA DIMENSIONS (LxM)	1000 mm x 1000 mm	1000 mm x 1000 mm	1000 mm x 1000 mm
ORIGIN	TURKEY	TURKEY	TURKEY

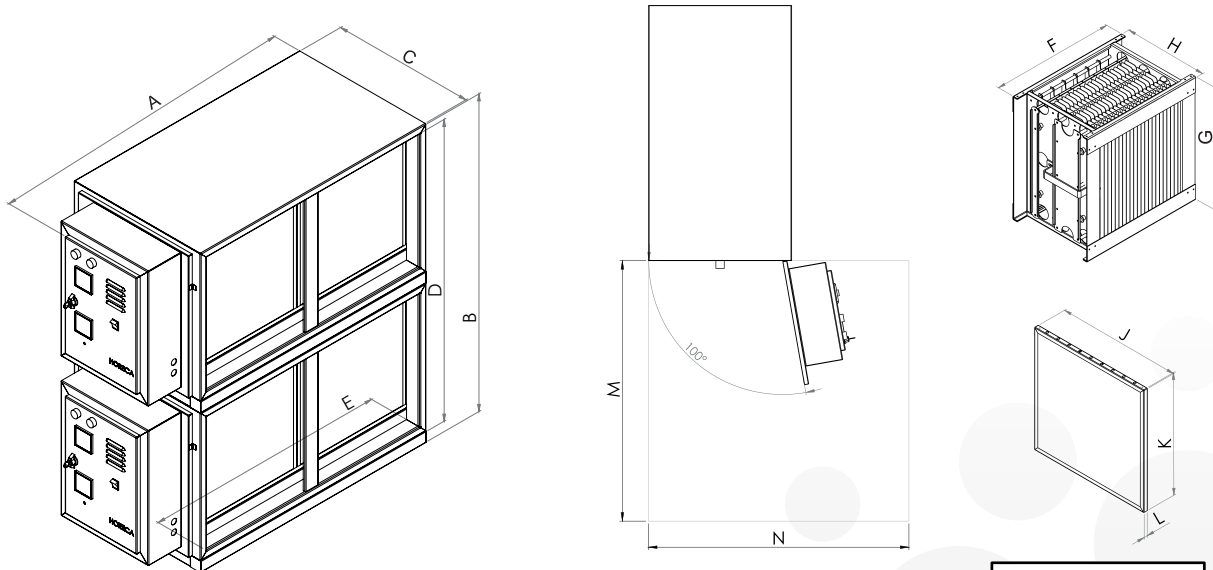



**CLEAN
SOLUTION**



CLEAN AIR ENGINEERING



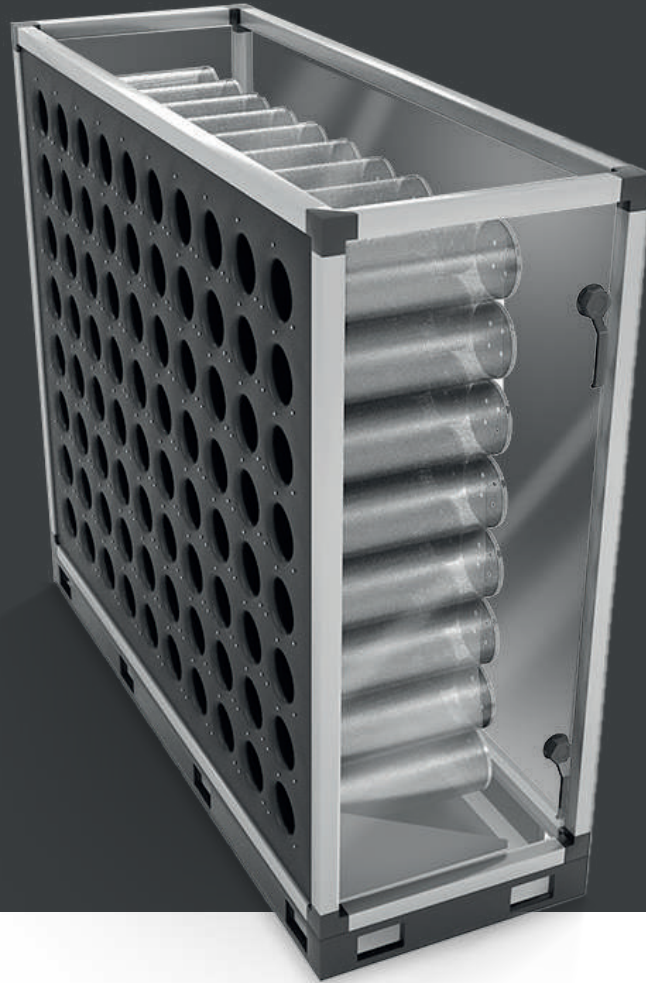

Active Carbon Filter, when used together with Electrostatic Filter, provides high efficiency odor filtration in industrial kitchens.



ACTIVATED CARBON FILTER

Advantages

- Easy assembly and installation with 4, 8 and 16 standard plates.
- High efficiency odor filtration.
- Low operating cost.

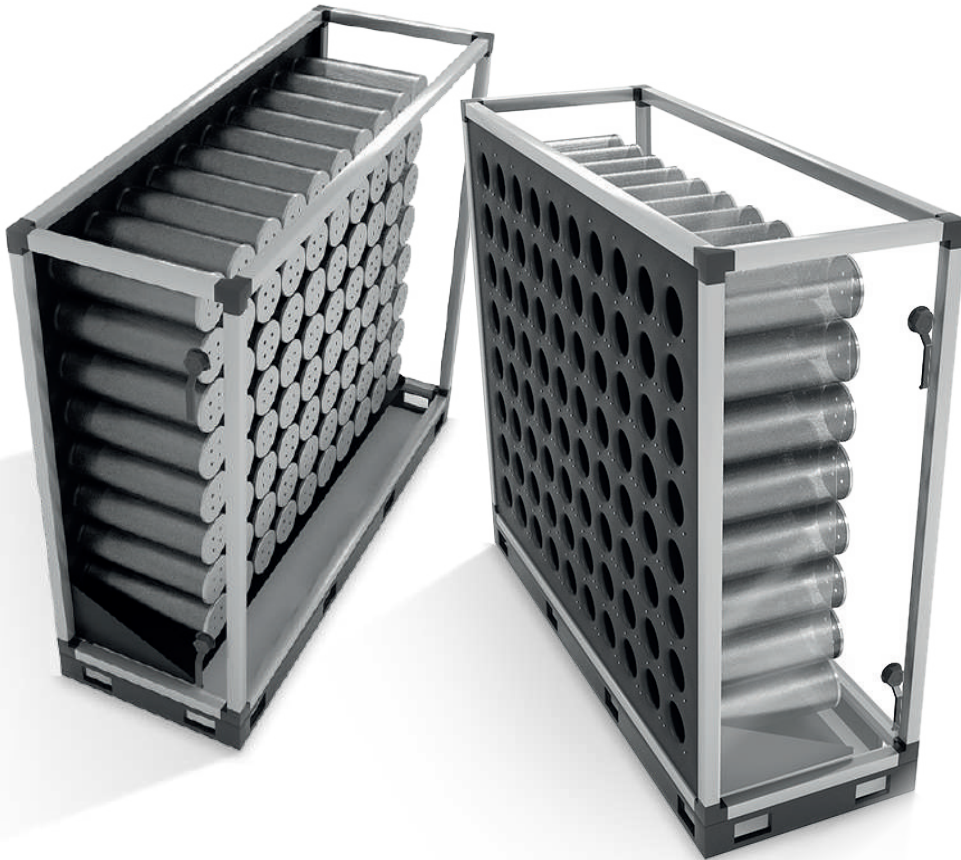

Activated carbon filters are used in kitchen filtration to eliminate odor particles after electrostatic filters.

The carbon filter used as a type of cartridge in kitchen filtration is made of microporous granules, which are small cylindrical in size of 3-4 mm and neutralize harmful organic compounds in the air stream.

The number of cartridges determined according to the air flow is applied in front of the fan after electrostatic filter in a cabinet. Maintenance and cleaning is not possible and the efficiency of the cleaning of the electrostatic filter can be up to **2 years**.

Horeca Activated Carbon Filters have;

- High Surface Area,
- Large internal porosity,
- High Gas Elimination Capacity,
- Low Pressure Loss, Energy Saving,
- Low Energy Consumption,
- Robustness and Airtightness,
- Easy Installation,
- Provides high efficiency in odor filtering with standard size.

Technical Specifications

MODEL	Diameter (mm)	Length (cm)	Number of Cartridges	Capacity (m³/h)	Total Carbon Mass (kg)	Cell Dimensions (AxBxC) (cm)	Contact Time (s)	Pressure Loss (Pa)
ACF-16	Ø 140	40	16	3.500	86	60x75x80	0.18	270
		50		4.350	60	70x75x80		
		60		5.250	72	80x75x80		
ACF-24		40	24	5.280	72	60x110x80		
		50		6.480	90	70x110x80		
		60		7.920	108	80x110x80		
ACF-32		40	32	7.040	96	60x75x140		
		50		8.640	120	70x75x140		
		60		10.560	144	80x75x140		
ACF-40		40	40	8.640	120	60x80x175		
		50		10.800	150	70x80x175		
		60		12.950	180	80x80x175		
ACF-48	40	48	10.560	144	60x100x130			
	50		12.960	180	70x100x130			
	60		15.840	216	80x100x130			
ACF-64	40	64	14.080	192	60x130x130			
	50		17.280	240	70x130x130			
	60		21.120	288	80x130x130			
ACF-72	40	72	15.840	216	60x140x150			
	50		19.800	270	70x140x150			
	60		23.760	324	80x140x150			
ACF-80	40	80	17.280	240	60x140x160			
	50		21.600	300	70x140x160			
	60		25.920	360	80x140x160			
ACF-96	40	96	21.120	288	60x130x200			
	50		25.920	360	70x130x200			
	60		31.680	432	80x130x200			

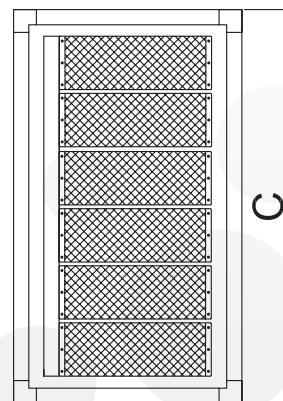
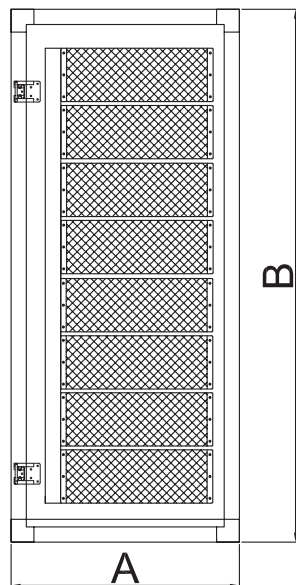

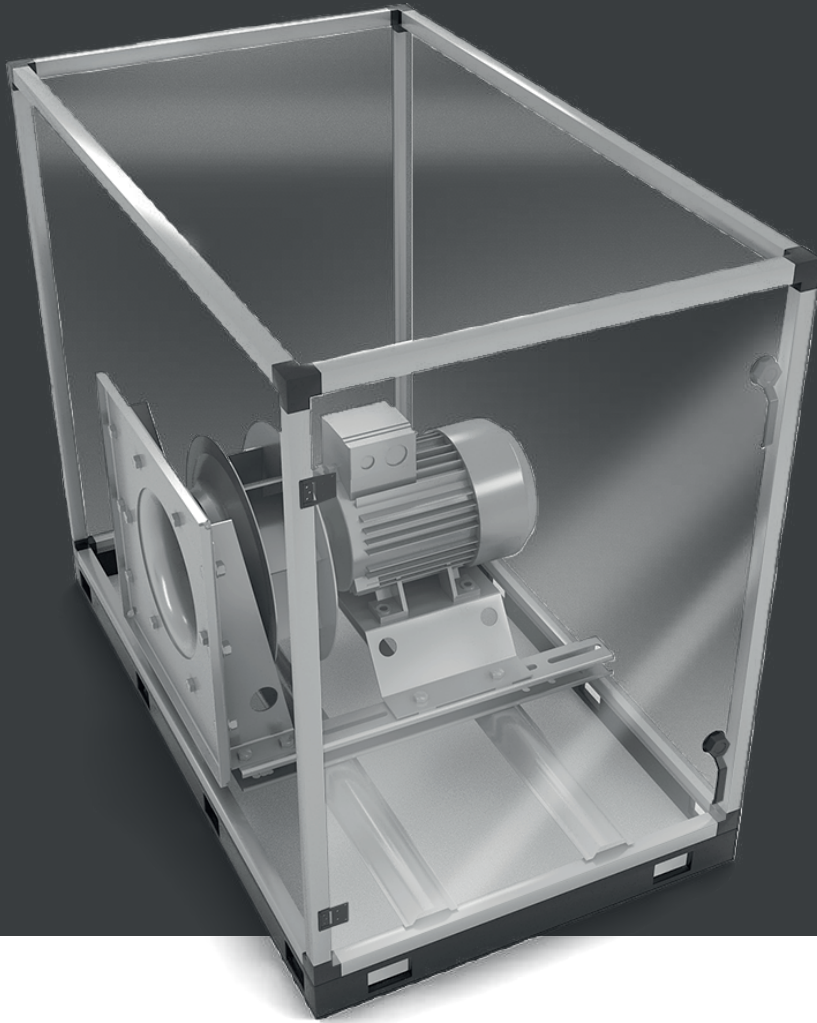

Exhaust Fans, are designed for use in industrial kitchens and evacuate filtered air from smoke, oil and odor to the outside.



EXHAUST FANS

Advantages

- With its special design, the electric motor stays out of the air flow.
- Low electricity consumption combined with the use of frequency inverters.
- Low noise level with soundproof cabin.

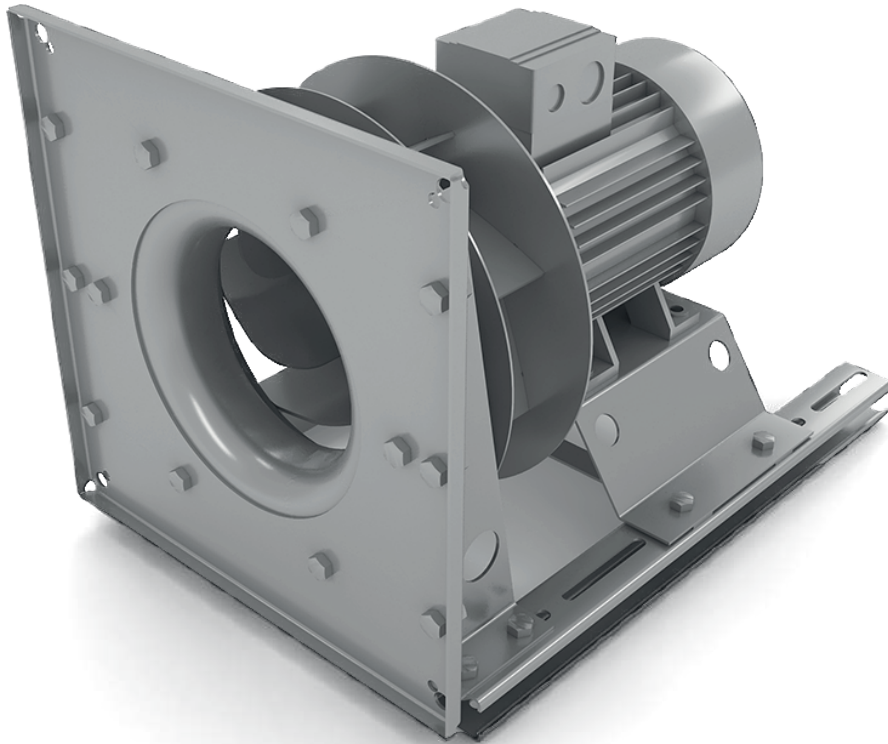

Kitchen Exhaust Systems

Industrial kitchen exhaust systems allow commercial kitchen and franchising investments, which are concentrated on food, to be made under more accurate application conditions. Thanks to the industrial kitchen exhaust systems, uncontrolled air movements that may occur between the kitchen volume and the adjacent comfort use volumes are prevented, thus the desired pressure balances in the comfort usage areas can be easily achieved.

Technical Specifications

MODEL	EF-2831	EF-3135	EF-3540	EF-4045	EF-5056	EF-5663	EF-6371
AIR FLOW RATE	2.500 m ³ /h	5.000 m ³ /h	7.500 m ³ /h	10.000 m ³ /h	15.000 m ³ /h	22.500 m ³ /h	30.000 m ³ /h
STATIC PRESSURE LOSS	500 Pa	500 Pa	500 Pa	500 Pa	500 Pa	500 Pa	500 Pa
TOTAL PRESSURE LOSS	1000 Pa	1000 Pa	1000 Pa	1000 Pa	1000 Pa	1000 Pa	1000 Pa
MOTOR POWER	1,1 kW	2,2 kW	4 kW	5,5 kW	5,5 kW	7,5 kW	15 kW
MOTOR SPEED	2885 d/d	2875 d/d	3150 d/d	2870 d/d	2220 d/d	1830 d/d	1880 d/d
FAN SPEED	2878 d/d	2860 d/d	2951 d/d	2731 d/d	2123 d/d	1682 d/d	1861 d/d
SOUND LEVEL	82 dB	83 dB	85 dB	86 dB	86 dB	87 dB	88 dB

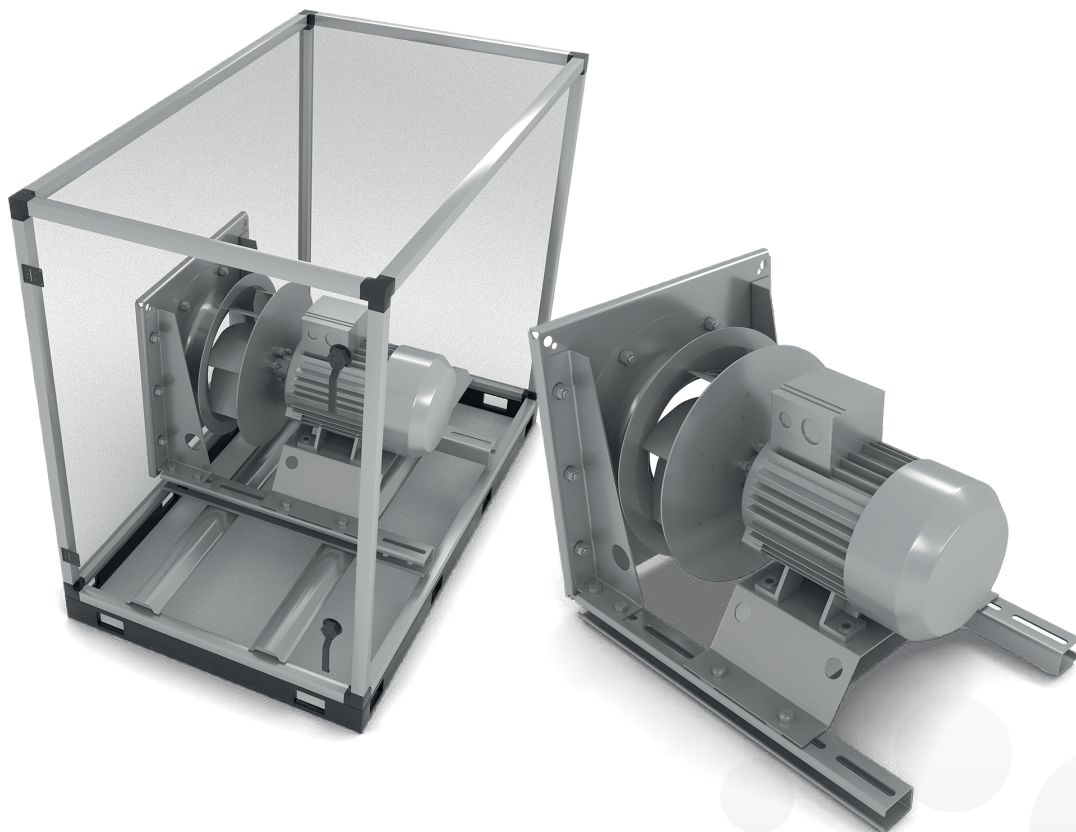



Ecology Units, are the most effective system where all the equipment required for industrial kitchen filtration is gathered in a single power plant.



ECOLOGY UNITS

Assembling the filter devices in a single unit;

- Efficiency and time savings as there is no channel connection between filter devices,
- All modules are independent of each other and easy on-site assembly,
- Protection from external factors such as rain and snow, thanks to its production suitable for the external environment,
- According to the project, the unit has advantages such as serving as a kitchen counter.



The kitchen ecology unit, is the most compact solution for oil, smoke and odor evacuation, which is one of the biggest problems of industrial kitchens.

The most important criterion in the selection of ecology units is the **type of kitchen.** Device capacities should be determined and their configurations should be made, taking into account conditions such as cooking intensity and the location of the business.

Kitchen ecology units, which contain all the necessary equipment to prevent oil, smoke and odor problems of a business, are produced in accordance with outdoor conditions and applied modularly.



Horeca Ecology Units

Ecology units;

- G4 Coarse Particle Trap Metal Filter,
- Electrostatic Filter,
- F7 Bag Filter,
- Activated Carbon Filter,
- Exhaust Fan,
- Control Panel

It is designed by configuring these components, which are determined specifically for each project, from parts such as.

Sample Installation





Technical Specifications

MODEL	KEFU-250/16-TG	KEFU-250/16-ÇG	KEFU-250/24-TG	KEFU-250/24-ÇG
ELECTROSTATIC FILTER CAPACITY	2.500 m ³ /h	2.500 m ³ /h	2.500 m ³ /h	2.500 m ³ /h
ACTIVATED CARBON FILTER CAPACITY	3.500 m ³ /h	3.500 m ³ /h	5.200 m ³ /h	5.200 m ³ /h
FAN CAPACITY	2.500 m ³ /h	2.500 m ³ /h	2.500 m ³ /h	2.500 m ³ /h
ELECTROSTATIC FILTER MODEL	HMD-300	HMD-300	HMD-300	HMD-300
NUMBER OF ELECTROSTATIC FILTER PASSES	1	2	1	2
NUMBER OF COLLECTOR CELLS	1	2	1	2
NUMBER OF ACTIVATED CARBON FILTER CARTRIDGES	16 PCS	16 PCS	24 PCS	24 PCS
EXTERNAL STATIC PRESSURE LOSS	500 Pa	500 Pa	500 Pa	500 Pa
TOTAL PRESSURE LOSS	1000 Pa	1000 Pa	1000 Pa	1000 Pa
FAN TYPE	PLUG Fan	PLUG Fan	PLUG Fan	PLUG Fan
MOTOR POWER	1,1 kW	1,1 kW	1,1 kW	1,1 kW
ENGINE SPEED	2885 d/d	2885 d/d	2885 d/d	2885 d/d
FAN SPEED	2875 d/d	2875 d/d	2875 d/d	2875 d/d
SOUND LEVEL	82 dB	82 dB	82 dB	82 dB
FREQUENCY INVERTER	Included	Included	Included	Included
AUTOMATION PANEL	Optional	Optional	Optional	Optional
DEVICE DIMENSIONS (AxBxC)	2350 mm x 750 mm x 800 mm	2350 mm x 750 mm x 800 mm	2350 mm x 750 mm x 800 mm	2350 mm x 750 mm x 800 mm
DUCT INPUT DIMENSIONS (DxE)	503 mm x 450 mm	503 mm x 450 mm	503 mm x 450 mm	503 mm x 450 mm
DUCT OUTPUT DIMENSIONS (FxF)	300 mm x 400 mm	300 mm x 400 mm	300 mm x 400 mm	300 mm x 400 mm
MASS	365 kg	420 kg	400 kg	460 kg
ORIGIN	TURKEY	TURKEY	TURKEY	TURKEY

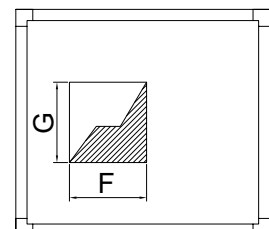
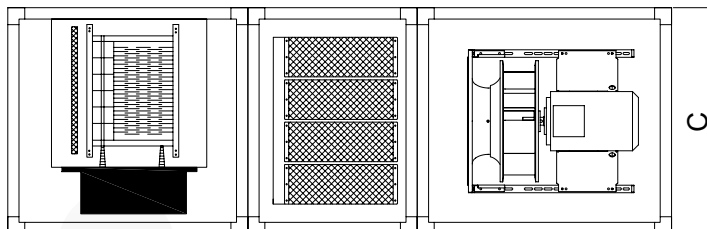
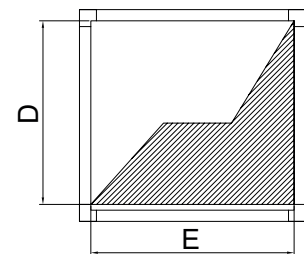
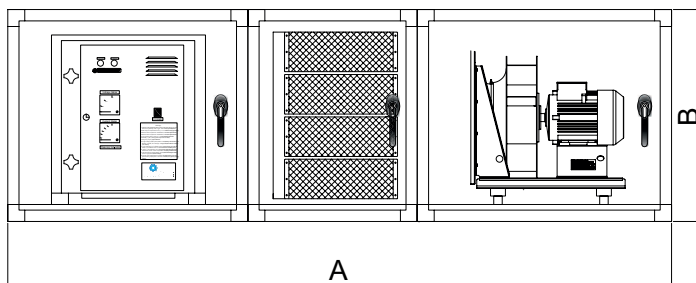

Technical Specifications

MODEL	KEFU-500/24-TG	KEFU-500/24-ÇG	KEFU-500/32-TG	KEFU-500/32-ÇG
ELECTROSTATIC FILTER CAPACITY	5.000 m ³ /h	5.000 m ³ /h	5.000 m ³ /h	5.000 m ³ /h
ACTIVATED CARBON FILTER CAPACITY	5.200 m ³ /h	5.200 m ³ /h	7.000 m ³ /h	7.000 m ³ /h
FAN CAPACITY	5.000 m ³ /h	5.000 m ³ /h	5.000 m ³ /h	5.000 m ³ /h
ELECTROSTATIC FILTER MODEL	HMD-600	HMD-600	HMD-600	HMD-600
NUMBER OF ELECTROSTATIC FILTER PASSES	1	2	1	2
NUMBER OF COLLECTOR CELLS	2	4	2	4
NUMBER OF ACTIVATED CARBON FILTER CARTRIDGES	24 PCS	24 PCS	32 PCS	32 PCS
EXTERNAL STATIC PRESSURE LOSS	500 Pa	500 Pa	500 Pa	500 Pa
TOTAL PRESSURE LOSS	1000 Pa	1000 Pa	1000 Pa	1000 Pa
FAN TYPE	PLUG Fan	PLUG Fan	PLUG Fan	PLUG Fan
MOTOR POWER	2,2 kW	2,2 kW	2,2 kW	2,2 kW
ENGINE SPEED	2875 d/d	2875 d/d	2875 d/d	2875 d/d
FAN SPEED	3000 d/d	3000 d/d	3000 d/d	3000 d/d
SOUND LEVEL	83 dB	83 dB	83 dB	83 dB
FREQUENCY INVERTER	Included	Included	Included	Included
AUTOMATION PANEL	Optional	Optional	Optional	Optional
DEVICE DIMENSIONS (AxBxC)	2400 mm x 750 mm x 1250 mm	3100 mm x 750 mm x 1250 mm	2400 mm x 750 mm x 1400 mm	3100 mm x 750 mm x 1400 mm
DUCT INPUT DIMENSIONS (DxE)	503 mm x 927 mm	503 mm x 927 mm	503 mm x 927 mm	503 mm x 927 mm
DUCT OUTPUT DIMENSIONS (FxW)	300 mm x 500 mm	300 mm x 500 mm	300 mm x 500 mm	300 mm x 500 mm
MASS	600 kg	685 kg	625 kg	700 kg
ORIGIN	TURKEY	TURKEY	TURKEY	TURKEY

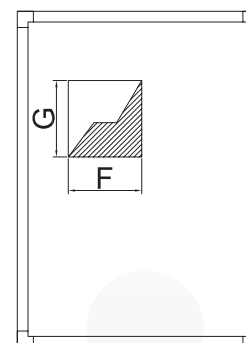
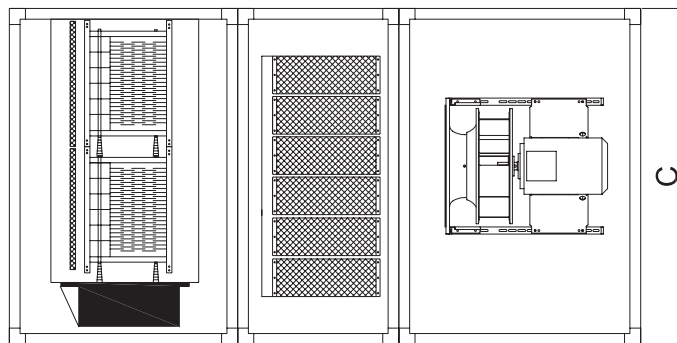
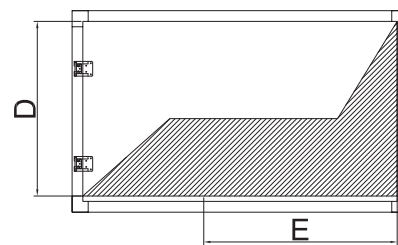
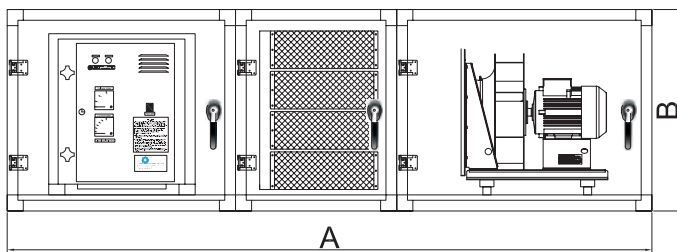

Technical Specifications

MODEL	KEFU-750/32-TG	KEFU-750/32-ÇG	KEFU-750/40-TG	KEFU-750/40-ÇG
ELECTROSTATIC FILTER CAPACITY	7.500 m ³ /h	7.500 m ³ /h	7.500 m ³ /h	7.500 m ³ /h
ACTIVATED CARBON FILTER CAPACITY	7.000 m ³ /h	7.000 m ³ /h	8.800 m ³ /h	8.800 m ³ /h
FAN CAPACITY	7.500 m ³ /h	7.500 m ³ /h	7.500 m ³ /h	7.500 m ³ /h
ELECTROSTATIC FILTER MODEL	HMD-900	HMD-900	HMD-900	HMD-900
NUMBER OF ELECTROSTATIC FILTER PASSES	1	2	1	2
NUMBER OF COLLECTOR CELLS	3	6	3	6
NUMBER OF ACTIVATED CARBON FILTER CARTRIDGES	32 PCS	32 PCS	40 PCS	40 PCS
EXTERNAL STATIC PRESSURE LOSS	500 Pa	500 Pa	500 Pa	500 Pa
TOTAL PRESSURE LOSS	1000 Pa	1000 Pa	1000 Pa	1000 Pa
FAN TYPE	PLUG Fan	PLUG Fan	PLUG Fan	PLUG Fan
MOTOR POWER	4 kW	4 kW	4 kW	4 kW
ENGINE SPEED	3150 d/d	3150 d/d	3150 d/d	3150 d/d
FAN SPEED	2951 d/d	2951 d/d	2951 d/d	2951 d/d
SOUND LEVEL	85 dB	85 dB	85 dB	85 dB
FREQUENCY INVERTER	Included	Included	Included	Included
AUTOMATION PANEL	Optional	Optional	Optional	Optional
DEVICE DIMENSIONS (AxBxC)	2500 mm x 800 mm x 1750 mm	3100 mm x 750 mm x 1250 mm	2400 mm x 750 mm x 1400 mm	3100 mm x 750 mm x 1400 mm
DUCT INPUT DIMENSIONS (DxE)	503 mm x 1417 mm	503 mm x 1417 mm	503 mm x 1417 mm	503 mm x 1417 mm
DUCT OUTPUT DIMENSIONS (F x W)	450 mm x 500 mm	450 mm x 500 mm	450 mm x 500 mm	450 mm x 500 mm
MASS	600 kg	685 kg	625 kg	700 kg
ORIGIN	TURKEY	TURKEY	TURKEY	TURKEY

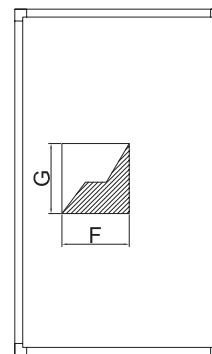
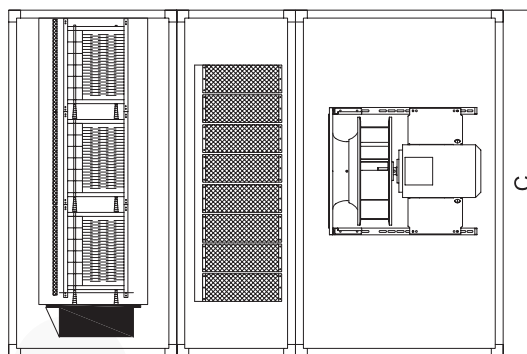
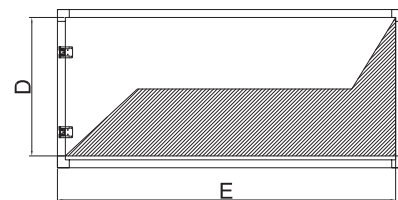
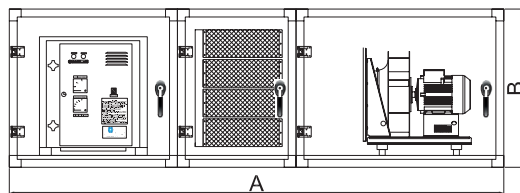

Technical Specifications

MODEL	KEFU-1000/48-TG	KEFU-1000/48-ÇG	KEFU-1000/64-TG	KEFU-1000/64-ÇG
ELECTROSTATIC FILTER CAPACITY	10.000 m ³ /h	10.000 m ³ /h	10.000 m ³ /h	10.000 m ³ /h
ACTIVATED CARBON FILTER CAPACITY	10.500 m ³ /h	10.500 m ³ /h	14.000 m ³ /h	14.000 m ³ /h
FAN CAPACITY	10.000 m ³ /h	10.000 m ³ /h	10.000 m ³ /h	10.000 m ³ /h
ELECTROSTATIC FILTER MODEL	HMD-1200	HMD-1200	HMD-1200	HMD-1200
NUMBER OF ELECTROSTATIC FILTER PASSES	1	2	1	2
NUMBER OF COLLECTOR CELLS	4	8	4	8
NUMBER OF ACTIVATED CARBON FILTER CARTRIDGES	48 PCS	48 PCS	64 PCS	64 PCS
EXTERNAL STATIC PRESSURE LOSS	500 Pa	500 Pa	500 Pa	500 Pa
TOTAL PRESSURE LOSS	1000 Pa	1000 Pa	1000 Pa	1000 Pa
FAN TYPE	PLUG Fan	PLUG Fan	PLUG Fan	PLUG Fan
MOTOR POWER	5,5 kW	5,5 kW	5,5 kW	5,5 kW
ENGINE SPEED	2870 d/d	2870 d/d	2870 d/d	2870 d/d
FAN SPEED	2731 d/d	2731 d/d	2731 d/d	2731 d/d
SOUND LEVEL	85 dB	85 dB	85 dB	85 dB
FREQUENCY INVERTER	Included	Included	Included	Included
AUTOMATION PANEL	Optional	Optional	Optional	Optional
DEVICE DIMENSIONS (AxBxC)	2500 mm x 1350 mm x 1400 mm	3250 mm x 1350 mm x 1250 mm	2500 mm x 1400 mm x 1400 mm	3250 mm x 1400 mm x 1400 mm
DUCT INPUT DIMENSIONS (DxE)	1103 mm x 927 mm	1103 mm x 927 mm	1103 mm x 927 mm	1103 mm x 927 mm
DUCT OUTPUT DIMENSIONS (FxW)	450 mm x 600 mm	450 mm x 600 mm	450 mm x 600 mm	450 mm x 600 mm
MASS	750 kg	830 kg	825 kg	925 kg
ORIGIN	TURKEY	TURKEY	TURKEY	TURKEY

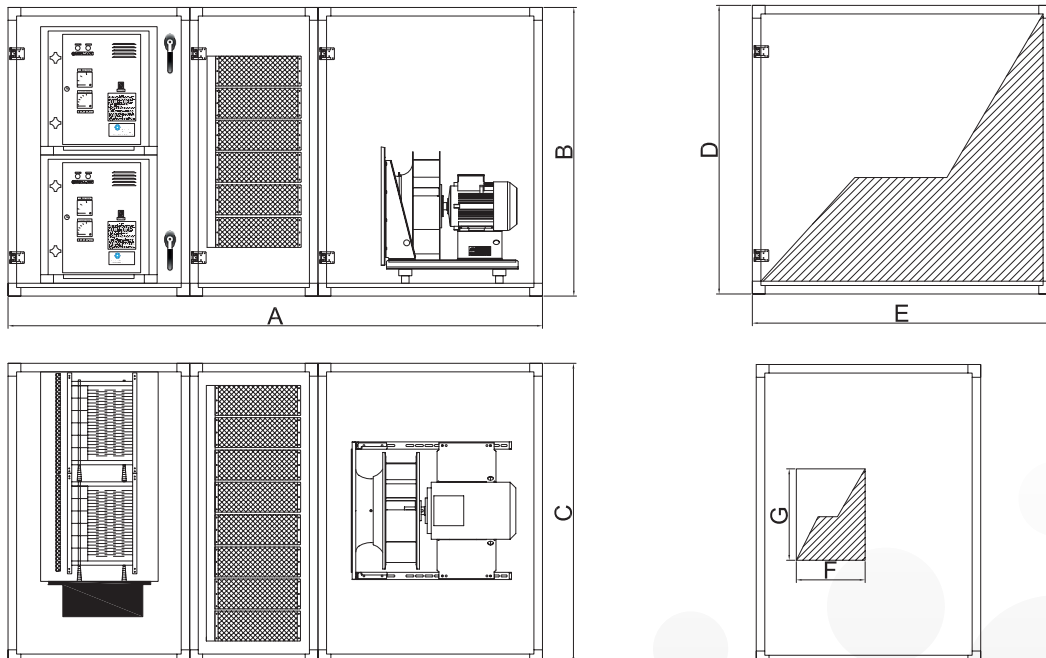

Technical Specifications

MODEL	KEFU-1250/56-TG	KEFU-1250/56-ÇG	KEFU-1250/72-TG	KEFU-1250/72-ÇG
ELECTROSTATIC FILTER CAPACITY	15.000 m ³ /h	15.000 m ³ /h	15.000 m ³ /h	15.000 m ³ /h
ACTIVATED CARBON FILTER CAPACITY	12.000 m ³ /h	12.000 m ³ /h	15.500 m ³ /h	15.500 m ³ /h
FAN CAPACITY	15.000 m ³ /h	15.000 m ³ /h	15.000 m ³ /h	15.000 m ³ /h
ELECTROSTATIC FILTER MODEL	HMD-1800	HMD-1800	HMD-1800	HMD-1800
NUMBER OF ELECTROSTATIC FILTER PASSES	1	2	1	2
NUMBER OF COLLECTOR CELLS	4	8	4	8
NUMBER OF ACTIVATED CARBON FILTER CARTRIDGES	56 PCS	56 PCS	72 PCS	72 PCS
EXTERNAL STATIC PRESSURE LOSS	500 Pa	500 Pa	500 Pa <td 500 Pa	
TOTAL PRESSURE LOSS	1000 Pa	1000 Pa	1000 Pa	1000 Pa
FAN TYPE	PLUG Fan	PLUG Fan	PLUG Fan	PLUG Fan
MOTOR POWER	5,5 kW	5,5 kW	5,5 kW	5,5 kW
ENGINE SPEED	2220 d/d	2220 d/d	2220 d/d	2220 d/d
FAN SPEED	2123 d/d	2123 d/d	2123 d/d	2123 d/d
SOUND LEVEL	85 dB	85 dB	85 dB	85 dB
FREQUENCY INVERTER	Included	Included	Included	Included
AUTOMATION PANEL	Optional	Optional	Optional	Optional
DEVICE DIMENSIONS (AxBxC)	2550 mm x 1350 mm x 1750 mm	3300 mm x 1350 mm x 1750 mm	2500 mm x 1400 mm x 1750 mm	2250 mm x 1400 mm x 1750 mm
DUCT INPUT DIMENSIONS (DxE)	1103 mm x 1417 mm	1103 mm x 1417 mm	1103 mm x 1417 mm	1103 mm x 1417 mm
DUCT OUTPUT DIMENSIONS (FxF)	450 mm x 750 mm	450 mm x 750 mm	450 mm x 750 mm	450 mm x 750 mm
MASS	950 kg	1100 kg	1050 kg	1200 kg
ORIGIN	TURKEY	TURKEY	TURKEY	TURKEY

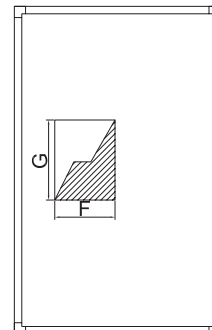
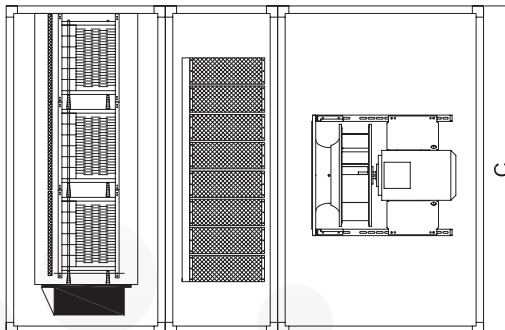
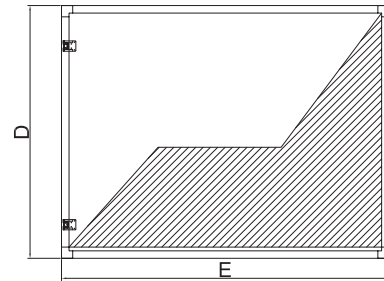
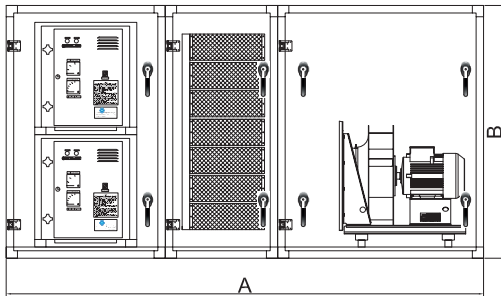

Technical Specifications

MODEL	KEFU-1500/64-TG	KEFU-1500/64-ÇG	KEFU-1500/80-TG	KEFU-1500/80-ÇG
ELECTROSTATIC FILTER CAPACITY	15.000 m ³ /h	15.000 m ³ /h	15.000 m ³ /h	15.000 m ³ /h
ACTIVATED CARBON FILTER CAPACITY	14.000 m ³ /h	14.000 m ³ /h	17.500 m ³ /h	17.500 m ³ /h
FAN CAPACITY	15.000 m ³ /h	15.000 m ³ /h	15.000 m ³ /h	15.000 m ³ /h
ELECTROSTATIC FILTER MODEL	HMD-1800	HMD-1800	HMD-1800	HMD-1800
NUMBER OF ELECTROSTATIC FILTER PASSES	1	2	1	2
NUMBER OF COLLECTOR CELLS	6	12	6	12
NUMBER OF ACTIVATED CARBON FILTER CARTRIDGES	64 PCS	64 PCS	80 PCS	80 PCS
EXTERNAL STATIC PRESSURE LOSS	500 Pa	500 Pa	500 Pa	500 Pa
TOTAL PRESSURE LOSS	1000 Pa	1000 Pa	1000 Pa	1000 Pa
FAN TYPE	PLUG Fan	PLUG Fan	PLUG Fan	PLUG Fan
MOTOR POWER	7,5 kW	7,5 kW	7,5 kW	7,5 kW
ENGINE SPEED	1830 d/d	1830 d/d	1830 d/d	1830 d/d
FAN SPEED	1682 d/d	1682 d/d	1682 d/d	1682 d/d
SOUND LEVEL	85 dB	85 dB	85 dB	85 dB
FREQUENCY INVERTER	Included	Included	Included	Included
AUTOMATION PANEL	Optional	Optional	Optional	Optional
DEVICE DIMENSIONS (AxBxC)	2700 mm x 1400 mm x 1750 mm	3450 mm x 1400 mm x 1750 mm	2700 mm x 1400 mm x 1750 mm	3450 mm x 1400 mm x 1750 mm
DUCT INPUT DIMENSIONS (DxE)	1103 mm x 1417 mm	1103 mm x 1417 mm	1103 mm x 1417 mm	1103 mm x 1417 mm
DUCT OUTPUT DIMENSIONS (FxW)	500 mm x 800 mm	500 mm x 800 mm	500 mm x 800 mm	500 mm x 800 mm
MASS	1050 kg	1200 kg	1150 kg	1300 kg
ORIGIN	TURKEY	TURKEY	TURKEY	TURKEY

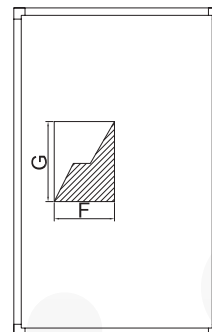
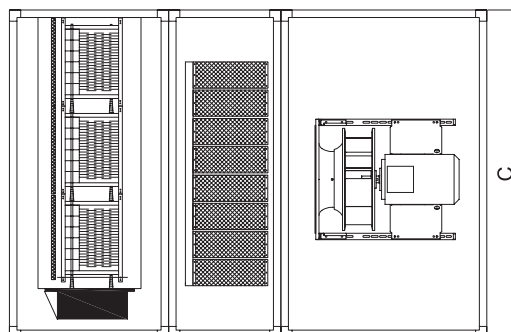
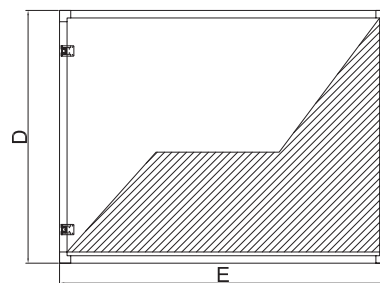
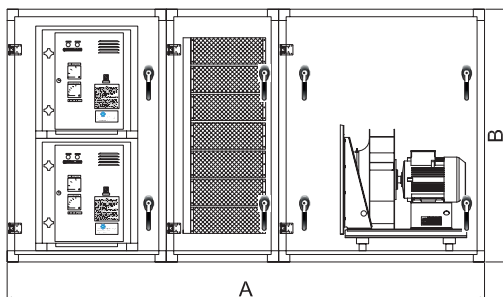

Technical Specifications

MODEL	KEFU-1750/80-TG	KEFU-1750/80-ÇG	KEFU-1750/104-TG	KEFU-1750/104-ÇG
ELECTROSTATIC FILTER CAPACITY	22.500 m ³ /h	22.500 m ³ /h	22.500 m ³ /h	22.500 m ³ /h
ACTIVATED CARBON FILTER CAPACITY	17.500 m ³ /h	17.500 m ³ /h	22.500 m ³ /h	22.500 m ³ /h
FAN CAPACITY	22.500 m ³ /h	22.500 m ³ /h	22.500 m ³ /h	22.500 m ³ /h
ELECTROSTATIC FILTER MODEL	HMD-2700	HMD-2700	HMD-2700	HMD-2700
NUMBER OF ELECTROSTATIC FILTER PASSES	1	2	1	2
NUMBER OF COLLECTOR CELLS	9	18	9	18
NUMBER OF ACTIVATED CARBON FILTER CARTRIDGES	80 PCS	80 PCS	104 PCS	104 PCS
EXTERNAL STATIC PRESSURE LOSS	500 Pa	500 Pa	500 Pa	500 Pa
TOTAL PRESSURE LOSS	1000 Pa	1000 Pa	1000 Pa	1000 Pa
FAN TYPE	PLUG Fan	PLUG Fan	PLUG Fan	PLUG Fan
MOTOR POWER	11 kW	11 kW	11 kW	11 kW
ENGINE SPEED	1830 d/d	1830 d/d	1830 d/d	1830 d/d
FAN SPEED	2060 d/d	2060 d/d	2060 d/d	2060 d/d
SOUND LEVEL	88 dB	88 dB	88 dB	88 dB
FREQUENCY INVERTER	Included	Included	Included	Included
AUTOMATION PANEL	Optional	Optional	Optional	Optional
DEVICE DIMENSIONS (AxBxC)	2700 mm x 1950 mm x 1750 mm	3450 mm x 1950 mm x 1750 mm	2700 mm x 2000 mm x 1750 mm	3450 mm x 2000 mm x 1750 mm
DUCT INPUT DIMENSIONS (DxE)	1703 mm x 1417 mm	1703 mm x 1417 mm	1703 mm x 1417 mm	1703 mm x 1417 mm
DUCT OUTPUT DIMENSIONS (F x W)	500 mm x 800 mm	500 mm x 800 mm	500 mm x 800 mm	500 mm x 800 mm
MASS	1350 kg	1500 kg	1400 kg	1550 kg
ORIGIN	TURKEY	TURKEY	TURKEY	TURKEY

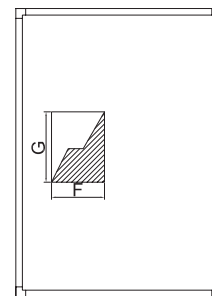
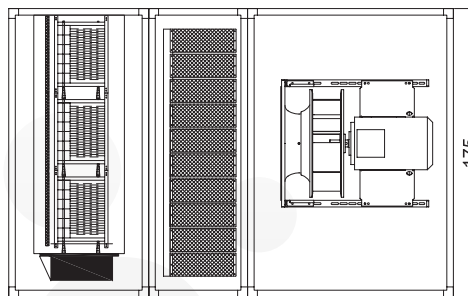
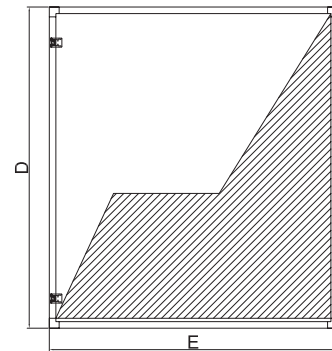
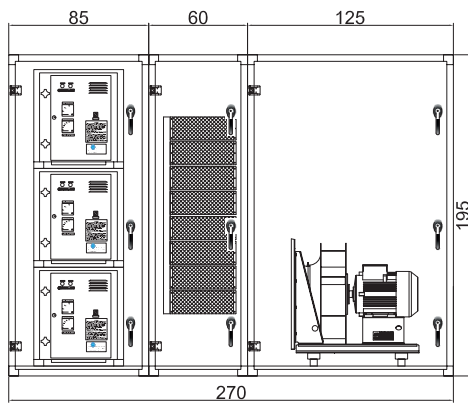

Technical Specifications

MODEL	KEFU-2000/96-TG	KEFU-2000/96-ÇG	KEFU-2000/120-TG	KEFU-2000/120-ÇG
ELECTROSTATIC FILTER CAPACITY	22.500 m ³ /h	22.500 m ³ /h	22.500 m ³ /h	22.500 m ³ /h
ACTIVATED CARBON FILTER CAPACITY	21.000 m ³ /h	21.000 m ³ /h	26.000 m ³ /h	26.000 m ³ /h
FAN CAPACITY	22.500 m ³ /h	22.500 m ³ /h	22.500 m ³ /h	22.500 m ³ /h
ELECTROSTATIC FILTER MODEL	HMD-2700	HMD-2700	HMD-2700	HMD-2700
NUMBER OF ELECTROSTATIC FILTER PASSES	1	2	1	2
NUMBER OF COLLECTOR CELLS	9	18	9	18
NUMBER OF ACTIVATED CARBON FILTER CARTRIDGES	96 PCS	96 PCS	120 PCS	120 PCS
EXTERNAL STATIC PRESSURE LOSS	500 Pa	500 Pa	500 Pa	500 Pa
TOTAL PRESSURE LOSS	1000 Pa	1000 Pa	1000 Pa	1000 Pa
FAN TYPE	PLUG Fan	PLUG Fan	PLUG Fan	PLUG Fan
MOTOR POWER	11 kW	11 kW	11 kW	11 kW
ENGINE SPEED	2060 d/d	2060 d/d	2060 d/d	2060 d/d
FAN SPEED	1954 d/d	1954 d/d	1954 d/d	1954 d/d
SOUND LEVEL	88 dB	88 dB	88 dB	88 dB
FREQUENCY INVERTER	Included	Included	Included	Included
AUTOMATION PANEL	Optional	Optional	Optional	Optional
DEVICE DIMENSIONS (AxBxC)	2700 mm x 2000 mm x 1750 mm	3450 mm x 2000 mm x 1750 mm	2700 mm x 2000 mm x 1750 mm	3450 mm x 2000 mm x 1750 mm
DUCT INPUT DIMENSIONS (DxE)	1703 mm x 1417 mm	1703 mm x 1417 mm	1703 mm x 1417 mm	1703 mm x 1417 mm
DUCT OUTPUT DIMENSIONS (FxW)	500 mm x 800 mm	500 mm x 800 mm	500 mm x 800 mm	500 mm x 800 mm
MASS	1400 kg	1550 kg	1450 kg	1600 kg
ORIGIN	TURKEY	TURKEY	TURKEY	TURKEY

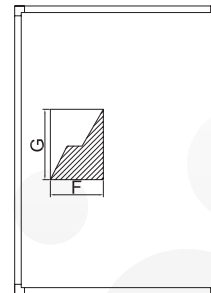
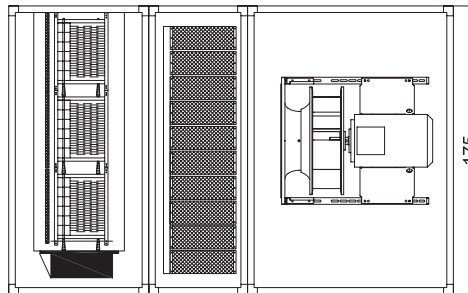
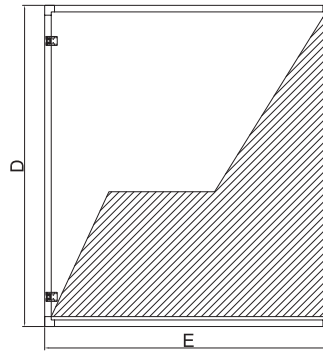
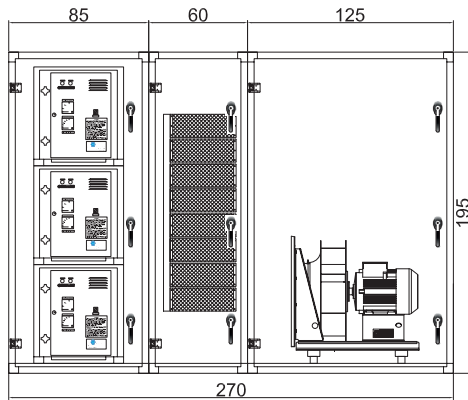

Technical Specifications

MODEL	KEFU-2250/100-TG	KEFU-2250/100-ÇG	KEFU-2250/132-TG	KEFU-2250/132-ÇG
ELECTROSTATIC FILTER CAPACITY	22.500 m ³ /h	22.500 m ³ /h	22.500 m ³ /h	22.500 m ³ /h
ACTIVATED CARBON FILTER CAPACITY	22.000 m ³ /h	22.000 m ³ /h	29.000 m ³ /h	29.000 m ³ /h
FAN CAPACITY	22.500 m ³ /h	22.500 m ³ /h	22.500 m ³ /h	22.500 m ³ /h
ELECTROSTATIC FILTER MODEL	HMD-2700	HMD-2700	HMD-2700	HMD-2700
NUMBER OF ELECTROSTATIC FILTER PASSES	1	2	1	2
NUMBER OF COLLECTOR CELLS	9	18	9	18
NUMBER OF ACTIVATED CARBON FILTER CARTRIDGES	100 PCS	100 PCS	132 PCS	132 PCS
EXTERNAL STATIC PRESSURE LOSS	500 Pa	500 Pa	500 Pa	500 Pa
TOTAL PRESSURE LOSS	1000 Pa	1000 Pa	1000 Pa	1000 Pa
FAN TYPE	PLUG Fan	PLUG Fan	PLUG Fan	PLUG Fan
MOTOR POWER	11 kW	11 kW	11 kW	11 kW
ENGINE SPEED	1710 d/d	1710 d/d	1710 d/d	1710 d/d
FAN SPEED	1540 d/d	1540 d/d	1540 d/d	1540 d/d
SOUND LEVEL	89 dB	89 dB	89 dB	89 dB
FREQUENCY INVERTER	Included	Included	Included	Included
AUTOMATION PANEL	Optional	Optional	Optional	Optional
DEVICE DIMENSIONS (AxBxC)	2700 mm x 1950 mm x 1750 mm	3450 mm x 1950 mm x 1750 mm	2700 mm x 2000 mm x 2000 mm	3450 mm x 2000 mm x 2000 mm
DUCT INPUT DIMENSIONS (DxE)	1703 mm x 1417 mm	1703 mm x 1417 mm	1703 mm x 1417 mm	1703 mm x 1417 mm
DUCT OUTPUT DIMENSIONS (FxW)	550 mm x 950 mm	550 mm x 950 mm	550 mm x 950 mm	550 mm x 950 mm
MASS	1450 kg	1600 kg	1500 kg	1650 kg
ORIGIN	TURKEY	TURKEY	TURKEY	TURKEY

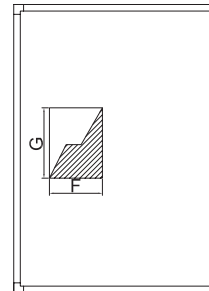
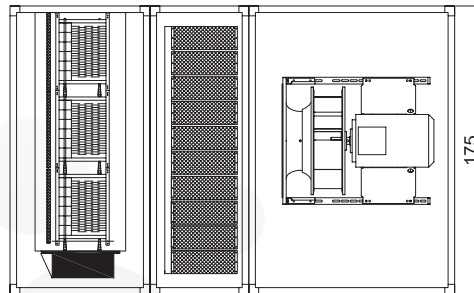
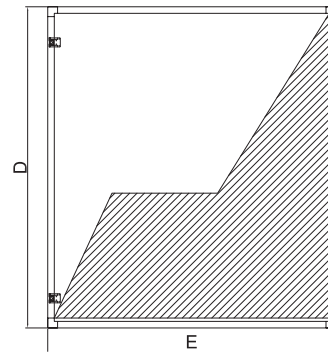
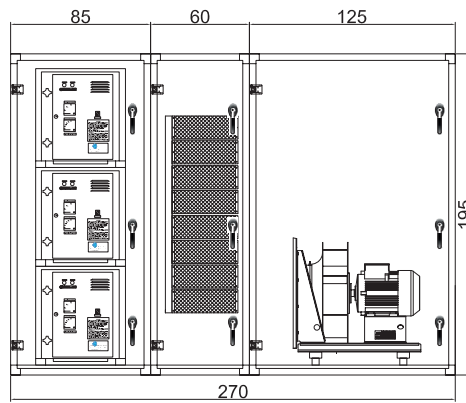

Technical Specifications

MODEL	KEFU-2500/128-TG	KEFU-2500/128-ÇG	KEFU-2500/144-TG	KEFU-2500/144-ÇG
ELECTROSTATIC FILTER CAPACITY	30.000 m³/h	30.000 m³/h	30.000 m³/h	30.000 m³/h
ACTIVATED CARBON FILTER CAPACITY	28.000 m³/h	28.000 m³/h	31.000 m³/h	31.000 m³/h
FAN CAPACITY	30.000 m³/h	30.000 m³/h	30.000 m³/h	30.000 m³/h
ELECTROSTATIC FILTER MODEL	HMD-3600	HMD-3600	HMD-3600	HMD-3600
NUMBER OF ELECTROSTATIC FILTER PASSES	1	2	1	2
NUMBER OF COLLECTOR CELLS	12	24	12	24
NUMBER OF ACTIVATED CARBON FILTER CARTRIDGES	128 PCS	128 PCS	144 PCS	144 PCS
EXTERNAL STATIC PRESSURE LOSS	500 Pa	500 Pa	500 Pa	500 Pa
TOTAL PRESSURE LOSS	1000 Pa	1000 Pa	1000 Pa	1000 Pa
FAN TYPE	PLUG Fan	PLUG Fan	PLUG Fan	PLUG Fan
MOTOR POWER	15 kW	15 kW	15 kW	15 kW
ENGINE SPEED	1880 d/d	1880 d/d	1880 d/d	1880 d/d
FAN SPEED	1861 d/d	1861 d/d	1861 d/d	1861 d/d
SOUND LEVEL	89 dB	89 dB	89 dB	89 dB
FREQUENCY INVERTER	Included	Included	Included	Included
AUTOMATION PANEL	Optional	Optional	Optional	Optional
DEVICE DIMENSIONS (AxBxC)	2850 mm x 2600 mm x 1750 mm	3600 mm x 2600 mm x 1750 mm	2850 mm x 2600 mm x 1750 mm	3600 mm x 2600 mm x 1750 mm
DUCT INPUT DIMENSIONS (DxE)	2303 mm x 1417 mm	2303 mm x 1417 mm	2303 mm x 1417 mm	2303 mm x 1417 mm
DUCT OUTPUT DIMENSIONS (FxBV)	550 mm x 950 mm	550 mm x 950 mm	550 mm x 950 mm	
MASS	1800 kg	1950 kg	1900 kg	2050 kg
ORIGIN	TURKEY	TURKEY	TURKEY	TURKEY

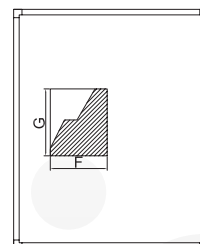
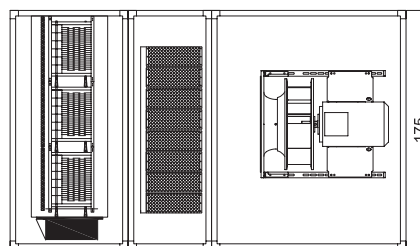
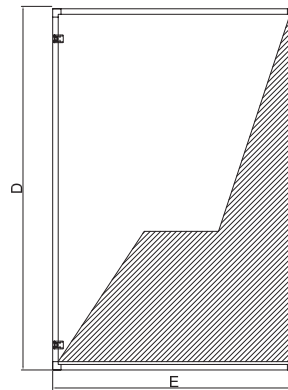
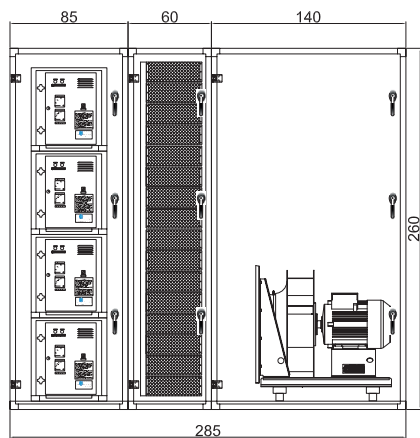

With Professional Staff, The Right Project
and Choosing The Appropriate Equipment

%98,7 OF THE SMOKE RELEASED
DURING COOKING IS FILTERED



www.emsamuhendislik.com

COMMERCIAL KITCHEN EXHAUST AND FILTRATION SOLUTIONS



**CLEAN
SOLUTION**







OTHER PRODUCTS

Airgold Portable Cooking Unit



Working Principle of Airgold Portable Cooking Unit

The oil vapor formed during cooking is collected in the hood with the exhaust fan integrated into the system. The oil and smoke particles in the polluted air advancing in the stainless air duct are kept with the help of the Electrostatic Filter in the system. The odor remaining in the air filtered from oil and smoke is released into the atmosphere in a smokeless and odorless manner by passing through the Activated Carbon Filters integrated into the system in appropriate amounts.

Since the emission values of the discharged air are low, the AIRGOLD Cooking Unit is environmentally friendly. With the filtering of oil, smoke and odor, there is no need for any air ducts or chimneys in the AIRGOLD Cooking Unit.

Working entirely with electricity, the AIRGOLD Cooking Unit consumes 1.5 kWh – 5.5 kWh. It is budget friendly with low power consumption.

Technical Specifications

MODEL	AIRGOLD-1250	AIRGOLD-2600	AIRGOLD-3400	AIRGOLD-5300
COOKING AREA LENGTH (mm)	1250	2600	3400	5300
COOKING AREA WIDTH (mm)	750	950	950	950
BENCH HEIGHT (mm)	800	850	850	850
ELECTRICAL VOLTAGE AND FREQUENCY (V/Hz)	220V /50 Hz	380 V/50 Hz	380 V/50 Hz	380 V/50 Hz
POWER USED (kW)	1,5 kW	2,2 kW	3 kW	5,5 kW
ACTIVATED CARBON FILTER	Optional	STANDART	STANDART	STANDART
MASS	250	700	1050	1450

MODEL	LENGTH (L)	WIDTH (W)	HEIGHT (H)
AIRGOLD-1250	1500 mm	1000 mm	2000 mm
AIRGOLD-2600	3200 mm	1250 mm	2250 mm
AIRGOLD-3400	4000 mm	1250 mm	2250 mm
AIRGOLD-5300	6000 mm	1250 mm	2250 mm

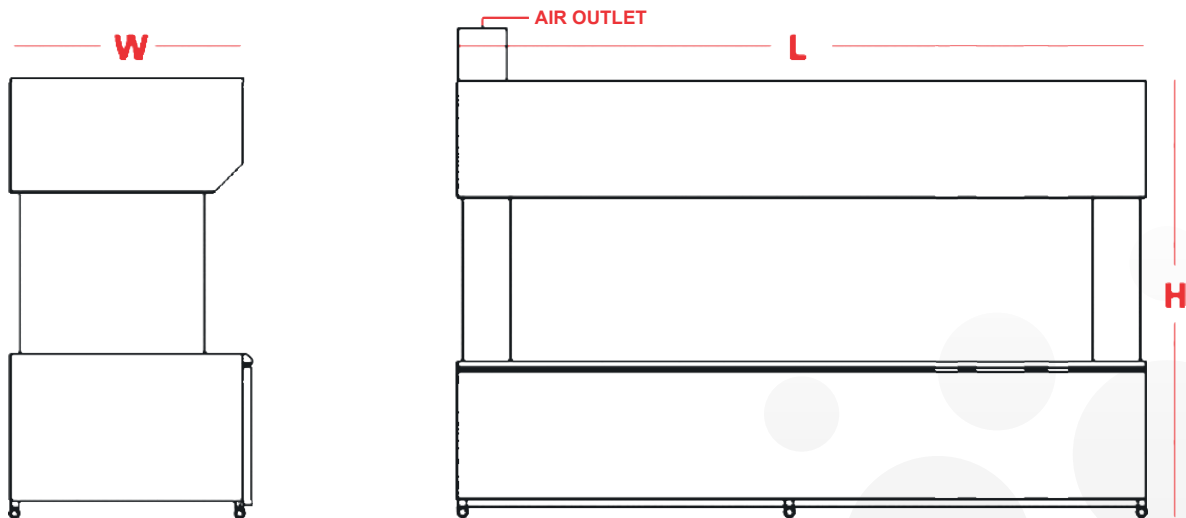

Control Panels

Frequency Control Panels are used to control the exhaust fan and filter system in environments where filtering systems are installed.

- The status / fault information and maintenance instructions on the HORECA Electrostatic Filter can also be read out via the control panel.
- In locations with a make-up air system, the frequency inverters of both devices (Filtration Device and Make-Up Air Device) are located in a single cabinet and are programmed so that the master-slave can operate synchronously.
- Frequency converters have a fire mode function. After the fire signal coming from the field, the frequency converter will start to operate at maximum speed and will ignore any error conditions.
- The panel of the filtration and make-up devices is connected via Modbus to the building management system.



- From the BMS, can get informations such as, Start / stop, fan running information, fan fault information, filter running information, ESP filter fault information, filter pollution warning information, air flow rate, fire mode operation information, manual operation information make up fan heating coil air outlet temperature information, freezing thermostat.
- When the Electrostatic Filter is not working, the control panels for operating the fan of the air cleaning system are equipped with BCS (By-Pass Control System).

Horeca HS Series Stainless Steel Honeycomb Filters

With a high filtration efficiency for large particle contaminants, a low overall resistance and tested and certified to a range of international standards, the HORECA stainless steel honeycomb filter is the most effective filter of its kind.

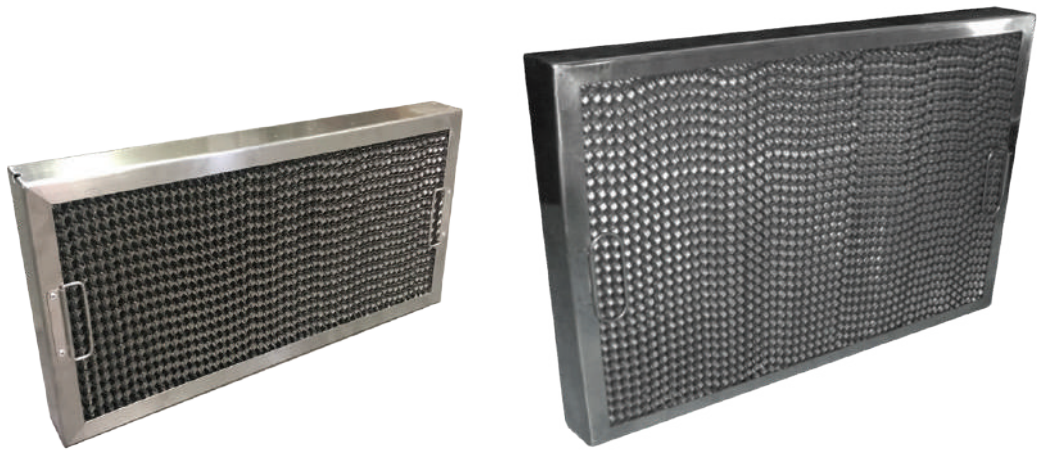

Model

Dimensions (mm)
Maximum Capacity

HS02

495 x 254 x 50 mm
828 m³/h, at 2.54 m/s speed

HS04

495 x 495 x 50 mm
1854 m³/h, at 2.54 m/s speed

HORECA oil, smoke and odor control application list in industrial kitchens

LOCATION	RESTAURANT
ANTALYA	HİLMİ KOKOREÇ
AXİS İSTANBUL	BAY DÖNER
AXİS İSTANBUL	KASAP DÖNER
AXİS İSTANBUL	MR.KUMPIR
AXİS İSTANBUL	MERSİN TANTUNİ
AXİS İSTANBUL	ARDEN FRIED CHICKEN
İST WEST AVM	HACI SAYID
MALL OF İSTANBUL	MC DONALDS
MALL OF İSTANBUL	NUR ABLA KARADENİZ SOFRASI
MALL OF İSTANBUL	RUMİ ETLİ EKMEK
MALL OF İSTANBUL	ŞİLE CAFE
MALL OF İSTANBUL	HAPPYMOONS
AQUA FLORYA AVM	MOĞOL BARBEKÜ
AQUA FLORYA AVM	GREEN SALADS
BEYLİKDÜZÜ	CAN-U CAN KÖFTE
ZORLU CENTER	ALAÇATI RESTORAN
ZORLU CENTER	FOCACCIA
ZORLU CENTER	ÇEVRE PAST.
ZORLU CENTER	TUNNEL GATE
BULVAR 216	PF CHANGS
UNIQ AVM	KARAFIRIN
VIAPORT VENEZZIA	MADD
VIAPORT VENEZZIA	BAY DÖNER
VIAPORT VENEZZIA	İKİ SATIR
VIAPORT VENEZZIA	ASLI BÖREK
VIAPORT VENEZZIA	KASAP DÖNER
VIAPORT VENEZZIA	KARAFIRIN
VIAPORT VENEZZIA	OYUN ALANI
BODRUM	DİVAN
VIAPORT KURTKÖY	FRESHBOX
KAVACIK	LOKANTIA
ESKİŞEHİR	KÖFTECİ YUSUF
İSTMARINA	BODRUM MANTI
İSTMARINA	İSLAMA KÖFTE
BAĞCILAR	BURGER 7
39 BURDA	DAVID PEOPLE
39 BURDA	BURSA KEBAP EVİ
39 BURDA	BEREKET DÖNER
ETİLER	NUSR-ET
BODRUM	NUSR-ET
DUBAI	NUSR-ET
ABU-DHABI	NUSR-ET
FETHİYE	KFC
KARTAL	KFC
KUŞADASI	KFC
BİLKENT	KFC
VIAPORT TUZLA	KFC
GÖZTEPE	KFC
MEYDAN AVM	KFC
ÇORLU ORİON	KFC
VIAPORT MARİNA	KFC
ATAŞEHİR	KFC
GÖKTÜRK	KFC
BURSA	KFC
SAKARYA	KFC
BATIKENT AVM	KFC
NEXT LEVEL AVM	KFC
OPTİMUM AVM	KFC
İZMİR	KFC
AKSARAY	KFC
ANKARA	KFC
AQUA FLORYA AVM	KFC

39 BURDA	TAVUK DÜNYASI
KAVACIK	TAVUK DÜNYASI
ANATOLIUM	TAVUK DÜNYASI
BODRUM	TAVUK DÜNYASI
İZMİR WESTPARK	TAVUK DÜNYASI
İZMİR MAGNESIA	TAVUK DÜNYASI
MANİSA	TAVUK DÜNYASI
AVLU34	TAVUK DÜNYASI
ISTMARINA	TAVUK DÜNYASI
ÇORLU ORİON	TAVUK DÜNYASI
SAPPHIRE	TAVUK DÜNYASI
İZMİR HILLTOWN	TAVUK DÜNYASI
KAZASKER	TAVUK DÜNYASI
TEM POINT	TAVUK DÜNYASI
MECİDİYEKÖY	TAVUK DÜNYASI
BAĞCILAR	TAVUK DÜNYASI
ÇANAKKALE	TAVUK DÜNYASI
BURSA PARKUR	TAVUK DÜNYASI
PİYALEPAŞA	TAVUK DÜNYASI
İZMİR OPTİMUM	TAVUK DÜNYASI
CÖKTÜRK	TAVUK DÜNYASI
ANTALYA	TAVUK DÜNYASI
ANKARA OPTİMUM	TAVUK DÜNYASI
GAZİANTEP	TAVUK DÜNYASI
DIYARBAKIR	TAVUK DÜNYASI
ANATOLIUM	TAVUK DÜNYASI
ISTMARINA	TAVUK DÜNYASI
39 BURDA	TAVUK DÜNYASI
BAHÇEŞEHİR	HASIRLI KONYA MUTFAĞI
EGE PERLA	BURSA KEBAP EVİ
MASLAK 1453	NAPOLIST PIZZA
PREMIER KAMPUS	PIZZA HUT
GAYRETTEPE	BURGERILLAS
ADANA	CARL'S JUNIORS
OSMANBEY	GARDEN İSKENDER
HADIMKÖY	BONFILET
ESENLER	ŞAKİR BURGER
YEŞİLKÖY	ŞAKİR BURGER
CEVİZLİBAÇ	ŞAKİR BURGER
BAYRAMPAŞA	ŞAKİR BURGER
BEŞİKTAŞ	FRANGO DÖNER
CAPACITY	GREEN SALADS
AQUA FLORYA	GREEN SALADS
KANYON	HUB RESTORAN
MALTEPE	MAHFEL SALONLARI
KADIKÖY	TARİHİ İSTANBUL KÖFTECİSİ
BAKIRKÖY	ETÇİL RESTORAN
BODRUM	TİKE
ANATOLIUM	HD İSKENDER
ANATOLIUM	PİDEM
ETİLER	NİSPETİYE KÖFTECİSİ
PENDİK	MARİNA BALIK
KARTAL	DEDEMAN OTEL
MASLAK	YEMEKHANE
MAVİ BAHÇE AVM	SIR WINSTON
MAVİ BAHÇE AVM	DEFNE AĞACI
CADDEBOSTAN	CADDE BALIK
HİSARÜSTÜ	PARK KASAP
ÇORLU	IZABELLA PIZZA
EDİRNE	IZABELLA PIZZA
KIRKLARELİ	IZABELLA PIZZA
ULUS	LIV HOSPITAL
İZMİR	UÇAN BALIK
HALKALI	NONNA
GÖZTEPE	ÇAYLA KAFE
KADIKÖY	ÇAYLA KAFE
NİŞANTAŞI	OTELİST
KADIKÖY	BASTA
ÜMRANIYE	GALA STEAKHOUSE
İSTİNYE	ŞEHİR STEAKHOUSE
AYAZAĞA	TİKE STEAKHOUSE
ZEKERİYAKÖY	MUNCHBOX
KONYA	ETİ ALÜMİNYUM
ACIBADEM	ACIBADEM DÖNER

ELAZIĞ	DEDECAN KEBAP
BEYOĞLU	PERA PARMA OTEL
KANDILLI	ALPERENLER CAFE
ANKARA	BİS RESTORAN
KAYSERİ	ŞAH MANGAL
KAYSERİ	MAKAM-I SULTAN
BURSA	BEEF BURGER
BURSA	SULTAN PİDE SALONU
ÇANAKKALE	ÖZ GIDA ET
SAMSUN	DONAS DÜRÜM
ADANA	PAPİNO RESTORAN
KAHRAMANMARAŞ	BEYZADE KEBAP
KIBRIS	KEL'İN YERİ RESTORAN
İSTMARINA	ÖZSÜT
AXİS İSTANBUL	ÖZSÜT
DUMANKAYA	ÖZSÜT
ANKARA TREN GARI	ÖZSÜT
NUROL PARK	ÖZSÜT
MEYDAN AVM	ÖZSÜT
İSTMARINA	ÖZSÜT
AVCILAR	BURGER YİYELİM
BEYKENT	BURGER YİYELİM
ÜMRANİYE	BURGER YİYELİM
ESENLER	BURGER YİYELİM
ŞİRİNEVLER	BURGER YİYELİM
BAKIRKÖY	BURGER YİYELİM
BAHÇELİEVLER	BURGER YİYELİM
SEFAKÖY	BURGER YİYELİM
SULTANGAZI	BURGER YİYELİM
KABATAŞ METRO DURAĞI	ULAŞIM A.Ş FORNETTI CAFE
1.LEVENT METRO DURAĞI	ULAŞIM A.Ş FORNETTI CAFE
MECİDİYEKÖY METRO DURAĞI	ULAŞIM A.Ş FORNETTI CAFE
CEVAHİR METRO DURAĞI	ULAŞIM A.Ş FORNETTI CAFE
GAYRETTEPE METRO DURAĞI	ULAŞIM A.Ş FORNETTI CAFE
4.LEVENT METRO DURAĞI	ULAŞIM A.Ş FORNETTI CAFE
GAYRETTEPE METRO DURAĞI	ULAŞIM,A.Ş FOCACCIA CAFE
TAKSİM METRO DURAĞI	ULAŞIM A.Ş KAVALYE CAFE
1.LEVENT METRO DURAĞI	ULAŞIM A.Ş KAVALYE CAFE
MALTEPE	BURGER KING
SANCAKTEPE	BURGER KING
GAZİOSMANPAŞA	BURGER KING
KÜÇÜKKÖY	BURGER KING
BURSA PARKUR	BURGER KING
İYAŞ AVM İSPARTA	SOMUNARASI KÖFTE
DENİZLİ	SOMUNARASI KÖFTE
ANTALYA	SOMUNARASI KÖFTE
ESKİŞEHİR	SOMUNARASI KÖFTE
VIAPORT VENEZİA	SOMUNARASI KÖFTE
VIAPORT	BAY DÖNER
KURTKÖY	BAY DÖNER
AXİS	BAY DÖNER
İSKENDERUN	BAY DÖNER
VIAPORT MARINA	BAY DÖNER
ÇAPA	TONTON BABA
ETİLER	TONTON BABA
FLORYA	TONTON BABA
SEFAKÖY	TONTON BABA
MAÇKA	TONTON BABA
ETİLER	HİLTON OTEL
YEŞİLKÖY	MİENYU CAFE
ETİLER	MICROSOFT
TOPHANE	MANA CAFE
KADIKÖY	KÖYÜM PİDE
GÖZTEPE	KÖYÜM PİDE
TOPHANE	MUMS CAFE
TOPHANE	PAPS CAFE
KOZYATAĞI	CIZGARA
ALTUNIZADE	VALIDEM CAFE
BÜYÜKADA	ADA GÜVEN CAFE
ADANA	HİKMET PİRZOLA

 **CLEAN AIR
ENGINEERING**



horeca
Commercial and Industrial Filtration Equipment

EMSA
INGEGNERIA

horeca

Clean Air Engineering



Province Istanbul District of Gaziosmanpasa, 559. Street No:19/ A

☎ +90 (212) 535 28 28 🌐 info@emsamuhendislik.com